

PHILIPS

AVENT

SCD921, SCD923



User manual

Table of contents

Introduction.....	4
General description.....	4
Important safety information	5
IMPORTANT	5
Preparing for use	7
Baby unit.....	7
Parent unit	7
Using the baby monitor.....	9
Linking parent unit and baby unit.....	9
App	11
Account management.....	12
Security and privacy.....	12
Positioning the baby monitor.....	13
Features and settings.....	15
Status light.....	15
Volume.....	17
Display brightness.....	18
Sound level lights.....	18
Modes and sensitivity.....	19
Nightlight.....	22
Soothing sounds	25
True talk-back.....	27
Menu features.....	28
Cleaning and maintenance	32
Storage.....	33
Ordering accessories.....	34
Disposal of your old product and battery	34
Environmental information.....	34
Remove the integrated battery.....	34
Guarantee and support.....	35
Troubleshooting	35
Wall mount	41

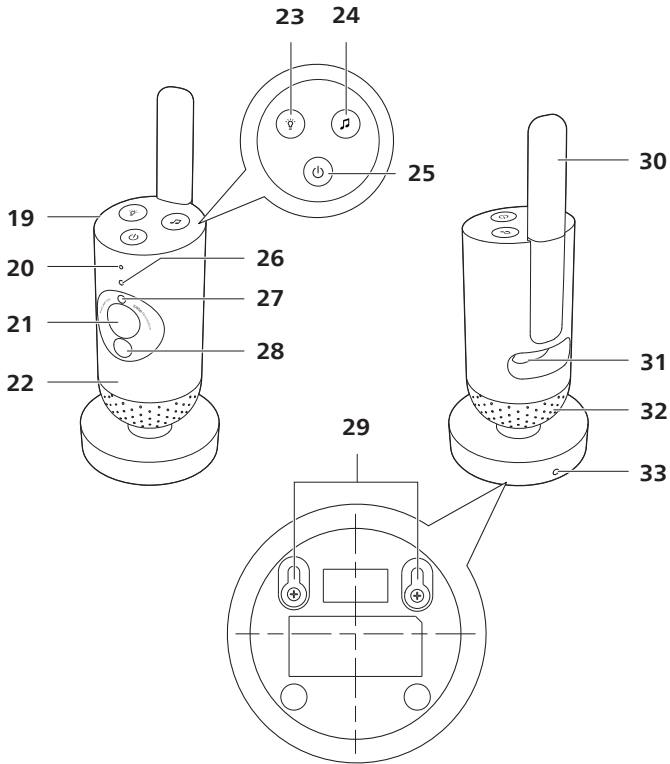
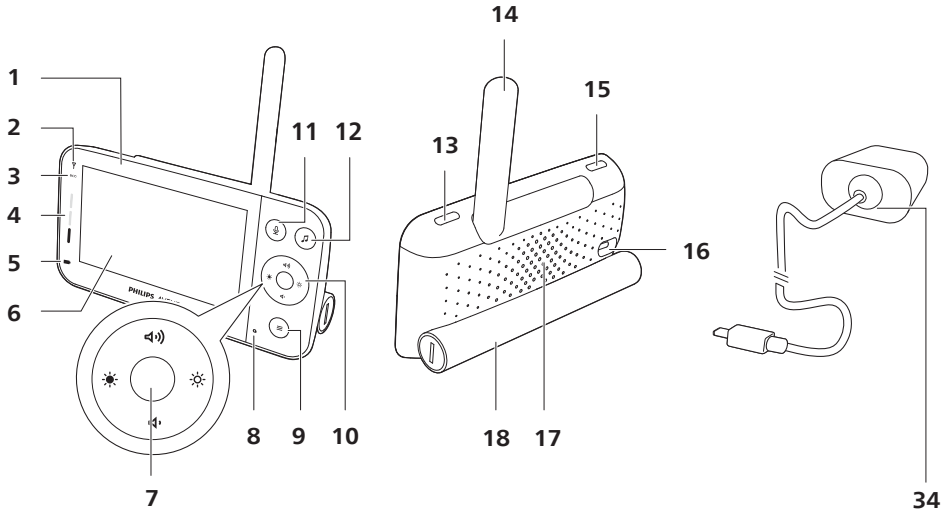

Introduction

Congratulations on your purchase and welcome to Philips Avent! To fully benefit from the support that Philips Avent offers, register your product at www.philips.com/welcome.

Keep an eye on your baby securely and from anywhere with the Philips Avent Connected Baby Monitor. Our Secure Connect System keeps you linked to your little one throughout home. And with the Baby Monitor+ app you can check in, and more, even when you need to be away.

General description

- 1 Parent unit
- 2 Link light
- 3 Eco-mode light
- 4 Sound level lights
- 5 Battery status light
- 6 Display
- 7 Confirm button
- 8 Microphone
- 9 Menu button
- 10 Control button (menu navigation/volume/brightness)
- 11 True talk back button
- 12 Soothing sounds button
- 13 On/off button
- 14 Foldable antenna
- 15 Mode button
- 16 Socket for power adapter
- 17 Speaker
- 18 Battery compartment
- 19 Baby unit
- 20 Microphone
- 21 Camera
- 22 Nightlight
- 23 Nightlight button
- 24 Soothing sounds button
- 25 On/off button
- 26 Status light
- 27 Ambient light sensor
- 28 Infrared light
- 29 Wall mounting holes
- 30 Antenna
- 31 Socket for power adapter
- 32 Speaker
- 33 Temperature sensor
- 34 Power adapter (2x)

Important safety information

Read this important information carefully before you use the appliance and save it for future reference.

IMPORTANT

This baby monitor is intended as an aid. It is not a substitute for responsible and proper adult supervision and should not be used as such.

Never leave your baby alone in your home. Always make sure there is someone present to look after the baby and take care of its needs.

Disclaimer

Please note that you use this baby monitor at your own risk. Koninklijke Philips N.V. and its subsidiary companies are not responsible for the operation of this baby monitor or your use of it and therefore do not accept any liability in connection with your use of this baby monitor.

Danger

- Never immerse any part of the baby monitor in water or any other liquid. Do not place the appliance where water or any other liquid can drip or splash onto it. Never use the baby monitor in moist places or close to water.
- Never put any object on top of the baby monitor and do not cover it. Do not block any ventilation openings. Install according to the manufacturer's instructions.

Warning

- Long cable. Strangulation hazard!
- Check if the voltage indicated on the adapter corresponds to the local mains voltage before you connect the appliance.
- Do not modify or cut off any part of the adapter and its cord, as this causes a hazardous situation.
- Only use the adapter supplied.
- If the adapter is damaged, always have it replaced with one of the original type in order to avoid a hazard.
- This appliance can be used by children aged from 8 years and above and persons with reduced physical, sensory or mental capabilities or lack of experience and knowledge if they have been given supervision or instruction concerning use of the appliance in a safe way and understand the hazards involved. Children shall not play with the appliance. Cleaning and user maintenance shall not be made by children without supervision.
- Protect the mains cord from being walked on or pinched particularly at plugs, and the point where they exit from the appliance.
- Make sure that you place the baby monitor in such a way that its cord does not obstruct a doorway or passage. If you place the baby monitor on a table or low cabinet, do not let the mains cord hang over the edge of the table or cabinet. Make sure the cord does not lie on the floor where it presents a tripping hazard.

- Keep the packaging materials (plastic bags, cardboard buffers, etc.) out of the reach of children, as they are not a toy.
- To prevent electric shock, do not open the housing of the baby unit or parent unit.

Battery safety instructions

- Only use the product for its intended purpose. Read this information carefully before you use the product and its batteries and accessories, and save it for future reference. Misuse can lead to hazards or serious injuries. Accessories supplied may vary for different products.
- Only use original Philips accessories and consumables. Only use detachable supply unit PS06H050K100xD or ASSA105x-050100 (x = E or B) series.
- Charge, use and store the product at a temperature between 0°C and 40°C.
- Keep product and batteries away from fire and do not expose them to direct sunlight or high temperatures.
- If the product becomes abnormally hot or smelly, changes colour or if charging takes longer than usual, stop using and charging the product and contact Philips consumer care centre.
- Do not place products and their batteries in microwave ovens or on induction cookers.
- Do not open, modify, pierce, damage or dismantle the product or battery to prevent batteries from heating up or releasing toxic or hazardous substances. Do not short-circuit, overcharge or reverse charge batteries.
- If batteries are damaged or leaking, avoid contact with the skin or eye. If this occurs, immediately rinse well with water and seek medical care.
- When you handle batteries, make sure that your hands, the product and the batteries are dry.
- To avoid accidental short-circuiting of batteries after removal, do not let battery terminals come into contact with metal objects (e.g. coins, hairpins, rings). Do not wrap batteries in aluminium foil. Tape battery terminals or put batteries in a plastic bag before you discard them.

Caution

- Use the appliance at a temperature between 0°C (32°F) and 40°C (104°F).
- Do not install the appliance near any heat sources such as radiators, heat registers, stoves or other apparatus (including amplifiers) that produce heat.
- Make sure that your hands are dry when you handle adapters, plugs and the mains cord.
- Screw covers / rubber pad can detach from the appliance, check on a regular basis.
- All required markings on the baby unit, parent unit and power adapter are located on the bottom of the baby unit, parent unit and power adapter.

Declaration of conformity

Hereby, Philips Electronics Hong Kong Limited declares that this product is in compliance with the essential requirements and other relevant provisions of Directive 2014/53/EU. A copy of the EC Declaration of Conformity (DoC) is available online at www.philips.com/support.

Compliance with EMF

This product complies with all applicable standards and regulations regarding exposure to electromagnetic fields.

Preparing for use

Baby unit

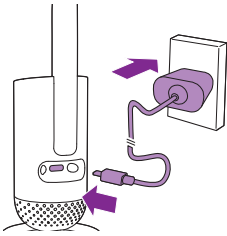

Plug the power adapter into the baby unit and the wall socket.

Parent unit

The parent unit runs on a built-in rechargeable Lithium-ion battery. Follow the below steps to charge the parent unit:

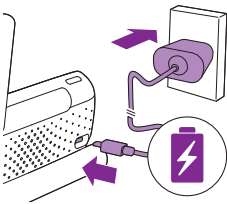

Plug the power adapter into the parent unit and the wall socket.

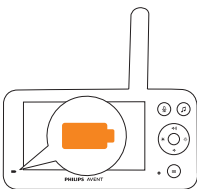

The battery status light turns orange to indicate that the appliance is charging.

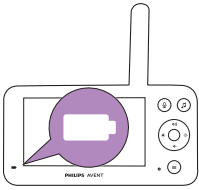

When the battery is fully charged, the battery status light turns a continuous white.

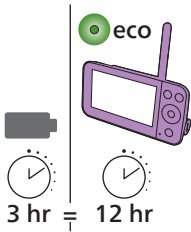

When you charge the parent unit for 3 hours, it can be used cordlessly for up to 12 hours in Eco mode.

If the parent unit is switched on during charging, charging takes approximately twice as long.

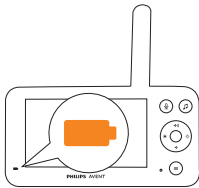

When the rechargeable battery of the parent unit is almost empty, the battery status light flashes orange and the low battery alert will sound. If the parent unit battery is empty and is not connected to the mains, the parent unit will switch off and connection to the baby unit will be lost.

Note: Only remove the built-in rechargeable battery when you discard the appliance. It is recommended that only authorized parties remove the battery.

Note: If the battery runs low, the parent unit's low battery alert sound may wake you up.

Note: The battery gradually and very slowly discharges, even when the parent unit is switched off.

Tip: To save battery, switch off the parent unit when not in use.

Tip: Keep the parent unit connected to the mains during the night.

Using the baby monitor

Linking parent unit and baby unit

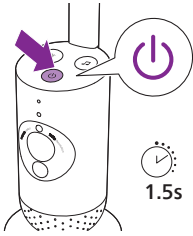

- 1 Press the on/off button for 1.5 seconds to turn on the baby unit.

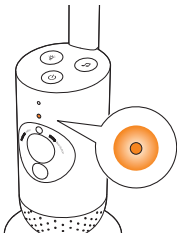

- 2 When the baby unit is on, the indicator light turns orange for booting-up.

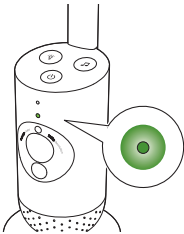

- 3 The baby unit is ready for use when the indicator light turns green, you can now connect it with the parent unit.

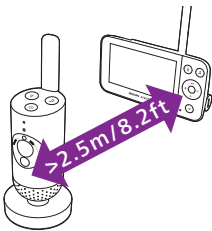

- 4 Make sure that the parent unit and the baby unit are at least 2.5 meters/ 8.2 feet away from each other to avoid acoustic feedback.

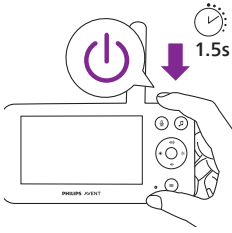

5 Press the on/off button for 1.5 seconds to turn on the parent unit.

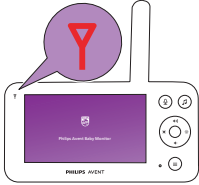

- The display turns on, the Philips shield appears on the display and the link light turns red. The parent unit starts to search for the baby unit.

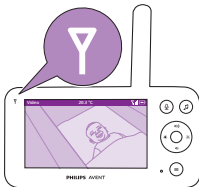

- When the parent unit and baby unit are linked, the link light turns white on the parent unit and one or more signal strength bars appear on the display.

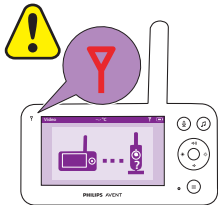

Note: It takes about 15 seconds to establish the link between the parent unit and the baby unit.

- Make sure that the baby unit is switched on. When the baby unit is switched off, the display of the parent unit will show the out of range image.
- If no connection has been established, the link light turns red, the parent unit alert will sound every 20 seconds and the out of range image appears on the display.

App

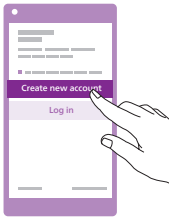
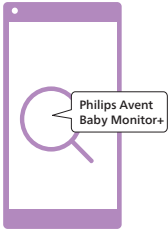

Before you start the set-up procedure, make sure:

- You have wireless Internet access (2.4 GHz Wi-Fi).
- You are close enough to the Wi-Fi router to have a good Wi-Fi signal.
- If you use a Wi-Fi repeater, make sure that your router and your Wi-Fi repeater have the same SSID (the network name) and that you use the same password for the router and the repeater.
- You have the password of your Wi-Fi network at hand. Always connect the baby monitor to a secure network (see the 'Security and privacy' chapter).

- 1 Make sure that your smart device runs on iOS 11 or higher, or Android 5 or higher. Download the Philips Avent Baby Monitor+ app from the App Store or Google Play. Use keywords 'Philips Avent Baby Monitor+' to search for the app.
- 2 Launch the app.

Tip: You get the best results if you connect your smart device to the Internet via Wi-Fi. It will then automatically use the Wi-Fi network to link to your baby monitor. When there is no Wi-Fi connection to the Internet, your smart device switches to its 3G or 4G mobile data connection. Use of this data connection may involve extra charges from your provider, depending on your subscription.

- 3 Follow the on-screen instructions to create an account.
 - a Make sure that you use a working email address on which you can always be reached.
 - b Use a strong password (see the 'Security and privacy' chapter).
 - c When you receive the verification email, follow the instructions in the email to continue creating your account.
- 4 Follow the instructions in the app to set up your baby monitor.

Account management

There are different access rights for the Admin user and Guest users. You can invite relatives or friends as guest users and allow them to monitor your baby on their smart devices.

	Admin User	Guest Users
Monitoring	Video Audio Background Temperature	Video Audio Background Temperature
Alerts notification	Sound detection Movement detection Temperature range detection	NA
Soothing features	Nightlight, soothing sounds, lullabies, true talk-back Voice recording	Nightlight, soothing sounds, lullabies, true talk-back
Account management	Guest user invitation	NA

Note: There is only one admin account per baby monitor. Don't share admin credentials with anyone outside of your immediate household.

Security and privacy

Network security

Don't use the app on an unsecured Wi-Fi network. We advise you to use the baby monitor only on a Wi-Fi network protected with WPA2 or higher encryption. With the app, you can also use your phone's data network (often referred to as 3G or 4G).

Wi-Fi hotspots in public places, such as airports and hotels, are convenient, but they are often not secure.

We advise you to use the baby monitor only on a Wi-Fi network protected with WPA2 or higher encryption. We advise you not to use the baby monitor on a network that uses WEP encryption.

Note: Wi-Fi networks that do not require a password are not secure.

Strong passwords

Passwords are essential to protect your Wi-Fi network and your account against unauthorised access. The stronger your password, the better protected your Wi-Fi network and your account is.

The rules for a strong password are:

- 1 Has at least 8 characters.
- 2 Does not contain your name, your baby's name, another real name or a brand name.
- 3 Does not contain a complete word.
- 4 Is very different from passwords that you have used before.
- 5 Contains characters from at least two of the following categories:
 - Letters, for example: A, B, C or a, b, c
 - Numbers: 0, 1, 2, 3, 4, 5, 6, 7, 8, 9
 - Symbols, for example: _ . @ \$

Provision of security updates

We continuously monitor the security of the software used in the product. If necessary, security updates will be provided through software updates. Software updates may also be provided to offer bugfixes and performance improvements, or to introduce new product features. Updates may be provided to the baby unit and parent unit firmware, or in the mobile app. Updates are wirelessly delivered to the product without the usage of special cables or equipment.

Philips will provide the necessary updates for a period of at least two years after the delivery of the product.

System compatibility

iOS compatibility: 11 or higher

Android compatibility: 5 or higher

Positioning the baby monitor



Warning: Long cable. Strangulation hazard!

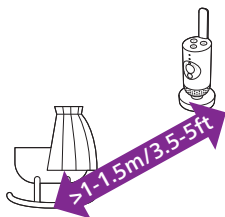

- 1 For optimal sound detection, make sure that the baby unit is no further than 1.5 meters/ 5 feet away from the baby. Make sure that the baby unit is at least 1 meter / 3.5 feet away from the baby because of potential strangulation hazard.

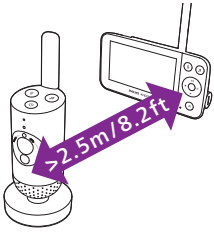

- 2 To avoid acoustic feedback, make sure that the parent unit is at least 2.5 meters / 8.2 feet away from the baby unit.

Note: If you use a cordless phone, wireless video, Wi-Fi network, microwave oven or Bluetooth device on 2.4 GHz and you experience interference on either the parent unit or baby unit, move the parent unit until there is no more interference.

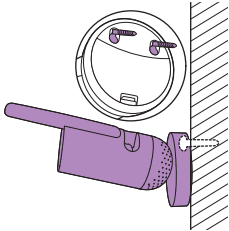

- 3 There are 2 ways to position the baby unit:
- a Place the baby unit on a stable, level and horizontal surface.
 - b Mount the baby unit to the wall with screws (not included).

Tip: The wall mount template (see the 'Wall mount' chapter) to mount the baby unit to the wall can be found at the end of this user manual.

Tip: Position the baby unit at a higher level to get a good overview of the baby's bed or playpen.

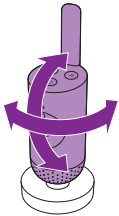

- 4 The baby unit can be rotated to ensure the best visibility of your baby.

Operating range

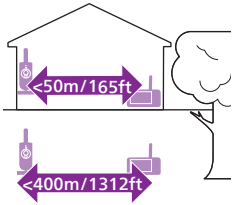

The operating range is up to 50 meters / 165 feet indoors and 400 meters / 1312 feet outdoors. The operating range of the baby monitor varies depending on the surroundings and factors that cause interference. Wet and moist materials cause so much interference that the range loss is up to 100%.

Dry materials	Material thickness	Loss of range
Wood, plaster, cardboard, glass (without metal, wires or lead)	< 30 cm (12 in)	0-10%
Brick, plywood	< 30 cm (12 in)	5-35%
Reinforced concrete	< 30 cm (12 in)	30-100%
Metal grilles or bars	< 1 cm (0.4 in)	90-100%
Metal or aluminium sheets	< 1 cm (0.4 in)	100%

Features and settings

Status light

Orange

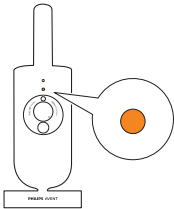

- 1 Solid orange: the baby unit is booting up.

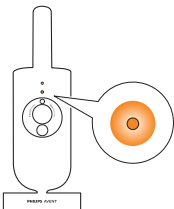

- 2 Flashes orange: the baby unit is upgrading its firmware. Do not switch it off during the upgrade.

Note: The baby unit might switch itself off briefly during the firmware upgrade.

Green

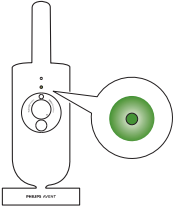

Solid green: the baby unit is ready to connect to the parent unit.

White

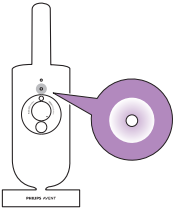

Solid white: the baby unit is ready to connect to the parent unit and app.

Red (Set up only)

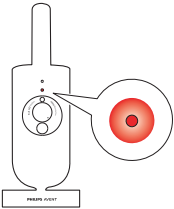

1 Flashes red: you have entered a wrong SSID ID or password.

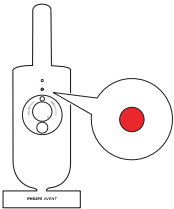

2 Solid red: the baby monitor failed to connect to internet.

Purple

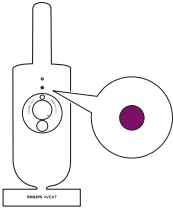

Solid purple: Video live streaming is turned on for one or more app users.

Volume

You can adjust the speaker volume of the parent unit to the level you prefer.

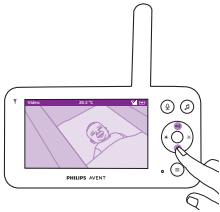

1 Press the top or bottom part of the control button to adjust the volume.

2 The volume bar appears on the display to show the selected volume level.



Note: If the volume is set to a high level, the parent unit consumes more power.

Note: When the volume bar is at its minimum, the volume is muted. The parent unit shows a mute icon in the status bar and you will only receive alerts and video from the parent unit.

Display brightness

You can adjust the display brightness of the parent unit to the level you prefer.

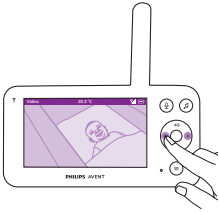

- 1 Press the left or right part of the control button to adjust the brightness of the display on the parent unit.



- 2 The brightness bar appears on the display to show the selected brightness level.

Note: The parent unit consumes more power with a higher brightness.

Sound level lights

The parent unit continuously monitors the sound level in your baby's room. The sound level lights on the parent unit let you know if there is any sound picked up in the baby's room.

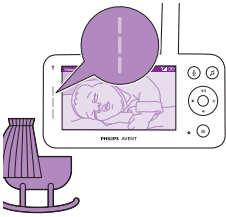

As long as no sound is detected, the sound level lights are off.

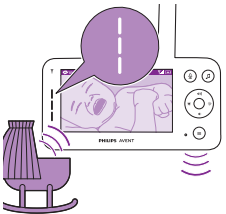

When the baby unit picks up a sound, one or more sound level lights on the parent unit turn white. The number of lights depends on the loudness of the sound picked up.

Modes and sensitivity

This baby monitor has three different modes that allow you to choose how you want to monitor your baby: Video, Audio, Eco.

The sensitivity level of the baby unit defines what you hear through the parent unit. When the level is set to high, you will hear many sounds, including soft background sounds. When the sensitivity level is set low, you will hear only the louder sounds.

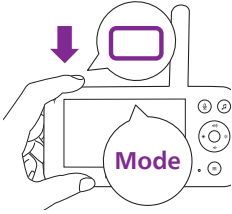

With the baby monitor on, press the mode button on the top left of the parent unit, press the top or bottom part of the control button to switch between these different modes, and then press the confirm button to select the desired mode.

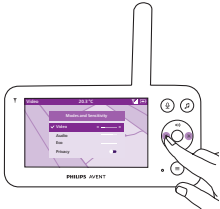

You can choose different sensitivity levels for different modes by pressing the left or right part of the control button.

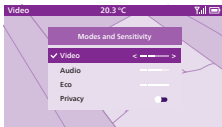

The display shows the selected mode.

The selected mode is also indicated in the status bar.

When turning on the device, the mode that was last used will be active.



If your baby only makes soft sounds, the sensitivity of the baby unit needs to be set to a high level on the parent unit.

The louder your baby sounds, the lower the sensitivity can be set on the parent unit.

Note: In Audio and Video mode, you will have continuous sound when the sensitivity level is set to the highest. Otherwise, low sounds will be muted.

Tip: The sensitivity level can be adjusted so you will always hear your baby without the disruption of other sounds. When there is a lot of background noise, turn down the sensitivity so that you will not hear these sounds through the parent unit.

Press the confirm button to save the new setting.

Video mode

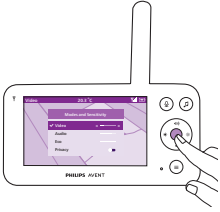

- 1 Press the mode button on the top left of the parent unit.
- 2 Press the confirm button to select the Video mode.

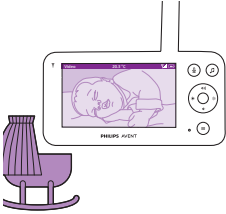

When the Video mode is activated, the display is always on.

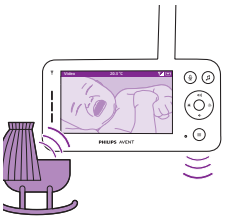

Note: Set the sensitivity level to the highest to have continuous sound on the parent unit.

Audio mode

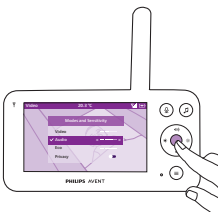

- 1 Press the mode button on the top left of the parent unit.
- 2 Press the bottom part of the control button to switch to Audio mode.
- 3 Press the confirm button to select the Audio mode.

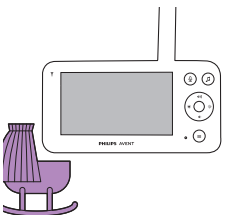

When the Audio mode is activated, the display of the parent unit switches off after 3 seconds.

Note: The status bar is not visible when the display is off.

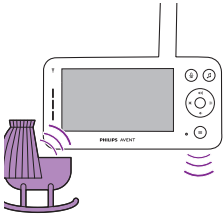

Note: The white link light shows that the parent unit is still on and connected to the baby unit.

Note: When sensitivity is not set to the highest level, low sounds will be muted.

Note: Set the sensitivity level to the highest to have continuous sound on the parent unit. Please see the 'Modes and sensitivity' chapter for more information.

If your baby makes any sound, the sound level lights turn on and the sounds detected by the baby unit are transmitted to the parent unit. As long as no sound is detected, the sound level lights are off.

Eco mode

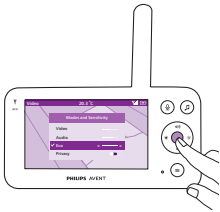

- 1 Press the mode button on the top left of the parent unit.
- 2 Press the bottom part of the control button to switch to Eco mode.
- 3 Press the confirm button to select the Eco mode.

Note: When the display is on, the selected mode will be visible in the status bar. The status bar is not visible when the display is off.

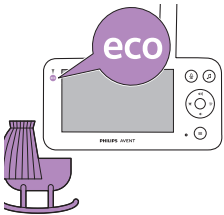

The display and sound level lights switch off when there is no sound detected for 20 seconds. The Eco-mode light turns white to indicate that the parent unit is still on and Eco mode is active.

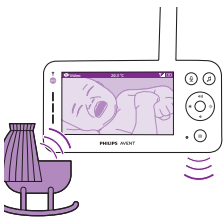

When sound is picked up by the baby unit, the display and sound level light of the parent unit turn on immediately. The video and sounds are transmitted to the parent unit and the sound level lights turn white. As long as no sound is detected, the sound level lights are off.

Note: The minimum sound level to activate sound and display is defined by the sensitivity setting.

Privacy function

Privacy mode allows you to temporarily disable the camera's live feed to the app. You can still monitor your baby from the parent unit in the selected mode.

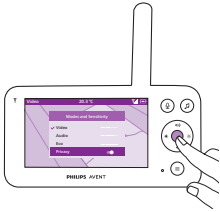

- 1 Press the mode button on the top left of the parent unit.
- 2 Press the bottom part of the control button to switch to Privacy function.
- 3 Press the confirm button to activate the Privacy function.

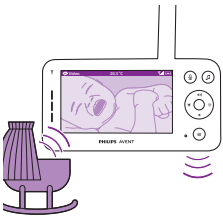

When the Privacy mode is activated, you can still monitor your baby from the parent unit in the selected mode.

Note: When the display is on, the privacy function indicator is shown in the status bar. The status bar is not visible when the display is off.



You cannot monitor your baby from the app when the privacy function is activated.

Tip: You will receive a push notification from the app when the privacy function is activated.

Nightlight

You can activate the nightlight function from the parent unit, the baby unit or the app.

To activate the nightlight function from the parent unit, follow the instructions below:

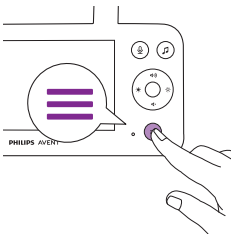

- 1 Press the menu button on the bottom right of the parent unit.

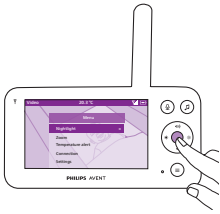

2 Choose Nightlight and press the confirm button to enter the setting options.



3 Press the confirm button to switch on and off the nightlight function.

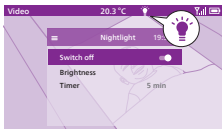

The display shows a light icon in the status bar when the nightlight is on.

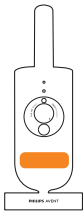

The nightlight of the baby unit turns on.

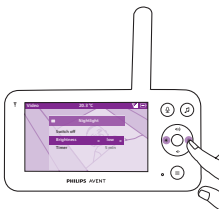

You can set the brightness level of the nightlight from the parent unit. Press the left or right part of the control button to choose low, medium or high.

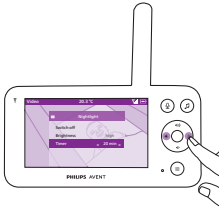

You can set the timer of the nightlight from the parent unit.
Press the left or right part of the control button to choose the time you prefer.

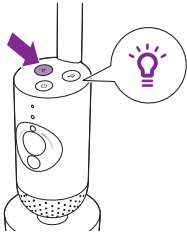

You can also control the nightlight from the baby unit.
1 Press the nightlight button on the baby unit to turn on the function.

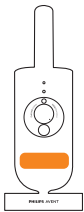

The nightlight turns on.

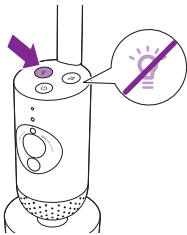

2 Press the nightlight button again to switch off.

Soothing sounds

You can activate the soothing sounds feature either from the parent unit, the baby unit or the app. To activate it from the parent unit, follow the instructions below:

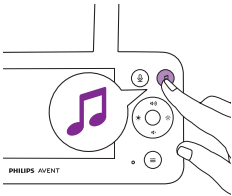

- 1 Press the soothing sounds button on the parent unit to open the menu.

Note: Pressing the button while the menu is already open, will close the menu.

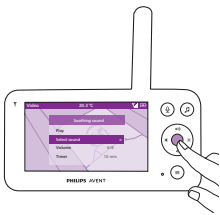

- 2 Press the bottom part of the control button to scroll down to 'Select sound' menu item, press the confirm button to enter the soothing sounds list.

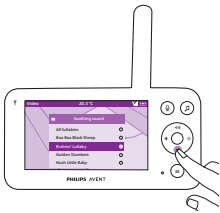

- 3 Press the top or bottom part of the control button to scroll through the list.
- 4 Press the confirm button to select or deselect the one you want to play. You can also select 'All lullabies' to playback the first 5 lullabies.

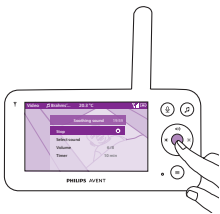

- 5 Navigate to 'Play' and press the confirm button to start playing the selected sound.

If you want to stop, press the confirm button again.

The status bar of the parent unit shows the name of sound that is being played.

Tip: Long-press the soothing sounds button to start playing the selected sound.

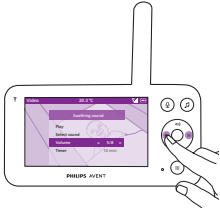

You can set the volume level of the sound or lullaby from the parent unit. Press the left or right part of the control button to choose the volume level.

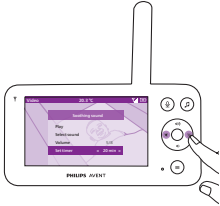

You can set a timer for the soothing sound to stop. Do this from the parent unit. Press the left or right part of the control button to choose the time you prefer.

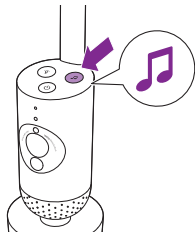

To activate the soothing sounds feature from the baby unit, press the soothing sounds button on the baby unit.

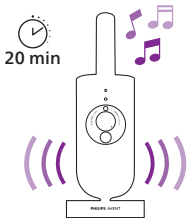

The latest sound selected on the parent unit starts to play continuously according to the last timer setting. To stop the soothing sounds on the baby unit, press the soothing sounds button again.

True talk-back

You can use the true talk-back button on the parent unit to talk to your baby.

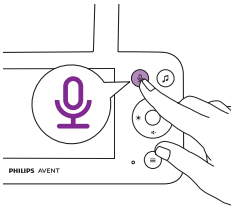

- 1 Press the true talk back button on the parent unit.



- 2 The display of the parent unit shows the true talk back icon, indicating the active connection. Talk clearly into the microphone at the front of the parent unit from a distance between 15-30 cm / 0.5-1 ft.



The baby can hear you talking into the parent unit. At the same time, you will hear any sounds your baby makes.

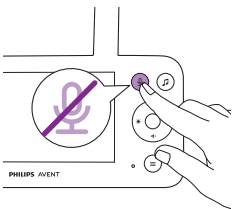

- 3 Press the true talk-back button again to turn off when you have finished talking.

Menu features

All features described in the following sections can be operated through the menu of the parent unit.

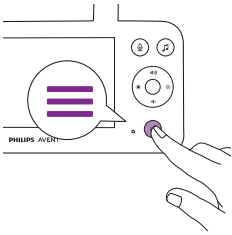

- 1 Press the menu button to enter the menu list.

Note: You will leave the menu when pressing the menu button again.

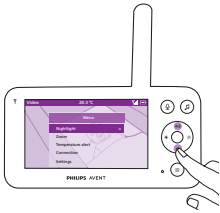

- 2 Use the control button to navigate through the menu. The selected menu item is highlighted purple.

Note: If you are already in one of the sub menus and you want to switch between menu features, press the menu button again to navigate back to the main menu.

Note: If you are in the menu but do not press a button for 8 seconds, the menu will exit without saving changed settings.

Zoom

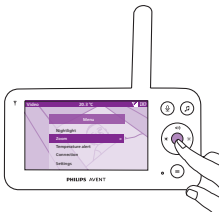

- 1 Press the confirm button to enter the zoom menu.

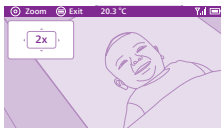

- 2 Press the confirm button to adjust the video image. You can use the top/bottom/right/left part of the control button to choose what part of the image will be shown on the parent unit.
- 3 Press the menu button to save the new setting and exit.
- 4 If you want to zoom out the image on the parent unit, go to the zoom menu and turn off the zoom function.

Tip: Long-press the confirm button for two seconds to get a quick access to the Zoom function.

Temperature alert

The temperature sensor enables you to monitor the temperature in your baby's room.

Note: The current temperature in your baby's room is shown in the status bar of the parent unit.

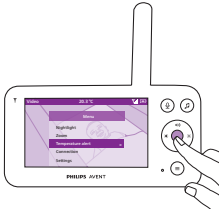

- 1 Press the confirm button to access the temperature alert menu.



- 2 The temperature alert can be set on or off, press the confirm button to turn it on or off.

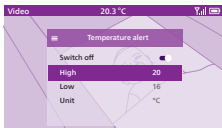

- 3 To change the maximum and minimum temperatures for the temperature alert, select the desired temperatures in the temperature menu.

Tip: You can change the temperature unit from C (Celsius) to F (Fahrenheit) by selecting the unit option.



- 4 Press the left part of the control button to save the new setting and return to the main menu.
- 5 The parent unit shows this alert when the measured temperature goes outside the range between the minimum and the maximum values.

Connection

You can choose different connection options with this menu feature. Direct + via Wi-Fi setting helps to extend the wireless range between the camera and parent unit by using your home Wi-Fi router as a bridge.



- 1 Press the confirm button to enter the connection menu.

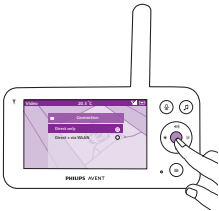

- 2 Press the top or bottom part of the control button and the confirm button to choose the desired connection.

Settings



Press the confirm button to access the settings menu.

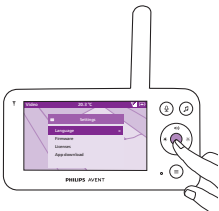

You can change the language setting of the parent unit.

- 1 Press the confirm button to access the list of languages.
- 2 Press the top or bottom part of the control button to scroll through all the languages and then press the confirm button to select the desired language.

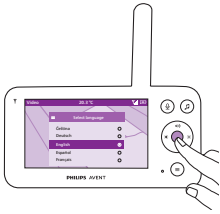

- 3 Press the confirm button to save the new setting and return to the main menu.

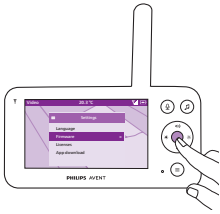

You can check and update the firmware of the parent unit.

- 1 Press the confirm button to enter the firmware menu.

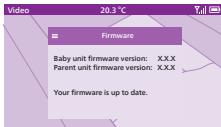

- 2 The display shows the latest firmware version of the parent unit and the baby unit.

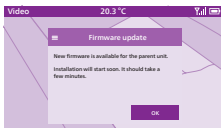

Note: When you see there is an update option, update the firmware for optimal product performance.

Tip: Make sure the parent unit is plugged to a mains socket with the provided adapter and it is placed close to the baby unit to complete the update.

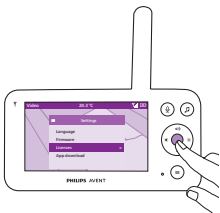

You can check the software license of the parent unit/baby monitor.

- 1 Press the confirm button to enter the license feature.



- 2 The display shows your baby monitor's license information.

Cleaning and maintenance

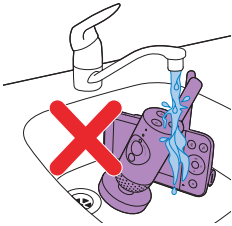

Warning: Do not immerse the parent unit, baby unit and power adapters in water and do not clean them under the tap.



Warning: Do not use cleaning sprays or liquid cleaners.

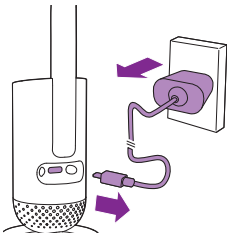

- 1 Switch off the baby unit, remove the power adapter from the baby unit and remove the power adapter from the wall socket.

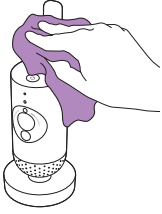

- 2 Clean the baby unit with a dry cloth.

Note: Fingerprints or dirt on the lens of the baby unit may affect the camera's performance. Avoid touching the lens with your fingers.

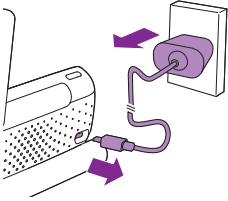

- 3 Switch off the parent unit, remove the power adapter from the parent unit and wall socket.

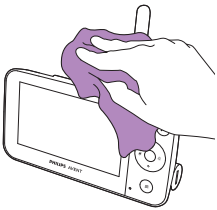

- 4 Clean the parent unit with a dry cloth.

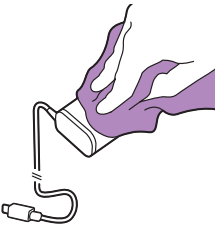

- 5 Clean the adapters with a dry cloth.

Storage

When you are not going to use the baby monitor for a long time, store the parent unit, the baby unit and adapters in a cool and dry place.

Ordering accessories

To buy accessories or spare parts, visit www.philips.com/parts-and-accessories or go to your Philips dealer. You can also contact the Philips Consumer Care Centre in your country (see the international warranty leaflet for contact details).

Disposal of your old product and battery



Your product is designed and manufactured with high quality materials and components, which can be recycled and reused.

This symbol on a product means that the product is covered by European Directive 2012/19/EU.

This symbol means that the product contains a built-in rechargeable battery covered by European Directive 2006/66/EC (which includes amendments from Directive 2013/56/EU) which cannot be disposed of with normal household waste. We strongly advise you to take your product to an official collection point or a Philips service centre to have a professional remove the rechargeable battery.

Follow your country's rules for the separate collection of electrical and electronic products and rechargeable batteries. Correct disposal helps prevent negative consequences for the environment and human health.



Environmental information

All unnecessary packaging has been omitted. We have tried to make the packaging easy to separate into two materials: cardboard box and polyethylene (bags, protective foam sheet).

Remove the integrated battery

Note: We strongly advise you to have a professional remove the rechargeable battery.

Only remove the rechargeable battery when you discard the appliance. Make sure the battery is completely empty when you remove it. Only the parent unit includes a battery.

Procedure:

- 1 Use a coin to unlock the openings of the battery compartment on the back of the parent unit.
- 2 Remove the 2 rubber feet at the bottom of the parent unit.
- 3 Remove the 2 screws that are now visible at the bottom of the parent unit.
- 4 Pull apart the battery compartment from the parent unit.
- 5 Remove the battery.

If there is no collection/recycling system for electronic products in your country, you can protect the environment by removing and recycling the battery before disposing the product. Make sure the product is disconnected from the charging case before removing the battery.

Guarantee and support

If you need information or support, please visit www.philips.com/support or read the international warranty leaflet.

General Information

Lithium-ion rechargeable battery (2600mAh)

Wi-Fi frequency band: IEEE 802.11 b/g/n 2.4GHz

Maximum radio-frequency power: ≤ 20 dBm e.i.r.p

Supply unit:

Model: ASSA105x-050100 / PS06H050K100xD

Input: 100-240V 50/60Hz ~ 0.35 A /
100-240V~, 50/60Hz, 0.25A

Output: 5.0V \equiv 1.0A, 5.0W

x = E (EU plug) / x = B (UK plug)

Average active efficiency: $\geq 73.62\%$

No-load power consumption (W): < 0.1 W

Troubleshooting

This chapter summarizes the most common problems you could encounter with the appliance. If you are unable to solve the problem with the information below, visit www.philips.com/support for a list of frequently asked questions or contact the consumer care centre in your country.

HOW TO USE / CONNECT THE UNITS

Problem	Solution
Why doesn't the parent unit charge when I plug it in?	Perhaps there is a battery error. Check the battery status light on the parent unit. If it is solid red, contact the consumer care centre in your country.
I cannot download and install the app. What can I do?	Please check if any of the following factors prevent a smooth download. Is your Wi-Fi signal stable and strong enough? Does your smart device run on iOS 11 or higher, Android 5 or higher? Do you have enough space left on your smart device to install the app? Did you enter the correct password for the App Store or Google Play?
Why can't I establish a connection between the parent unit and baby unit? Why is the connection lost every now and then? Why are there sound interruptions?	The baby unit and the parent unit are probably close to the outer limits of the operating range or there is interference from other 2.4 GHz wireless devices. Try a different location, decrease the distance between the units or switch off other 2.4 GHz wireless devices (laptops, mobile phones, microwaves, etc) . It can take up to 15 seconds to re-establish the connection between the units.

HOW TO USE / CONNECT THE UNITS

Problem	Solution
	Perhaps you have more than one set of baby monitor, or the baby and parent unit are too close to each other, keep them at least 1.5 meters / 5 feet away from each other to prevent interference.
How can I reset the baby unit?	You can reset the baby unit by long-pressing the on/off button for 10 seconds. The baby unit will reboot and the indicator light will flash in green and orange, the reset is completed when the indicator light turns solid green. All the settings will be removed after the reset, including the connected Wi-Fi router's SSIDs and passwords and the connected app users. You can reset the baby unit if you stop using the product and want to transfer it to a new user.

INDICATIONS ON THE PARENT UNIT

Problem	Solution
What does the colour of the battery status light mean?	When the parent unit is connected to the mains power the colour of the battery status light will show: * Solid white: battery is fully charged. * Solid orange: battery is charging. * Solid red: battery error. Please contact the consumer care centre in your country.
	When the parent unit is not connected to the mains power the colour of the battery status light will show: * Flashing orange: battery is almost empty (lower than 10%). Please charge the battery.
Why can the charging time of the parent unit exceed 3 hours?	The parent unit may be switched on during charging. When the display of the parent unit is constantly on, charging of the parent unit will take more time. Switch off the parent unit during charging to reduce the charging time.
	Perhaps temperature has exceeded the charging tolerance that could potentially cut off the charging circuit as a safety protection mechanism. To resume charging, move the charging station away from any heat sources such as radiators, heat registers, stove or other appliances (including amplifiers) that produce heat.
How can I restart the parent unit?	You can restart the parent unit by long-pressing the on/off button for 10 seconds. The parent unit will restart. Specific user information stored in the memory of the parent unit such as user mode, brightness settings, volume, lullaby selection, zoom selection will not be lost.

NOISE/SOUND

Problem	Solution
Why does the app, parent unit and/or baby unit produce a high-pitched noise?	Perhaps the app, parent unit and baby unit are too close to each other. Make sure they are at least 2.5 meters / 8.2 feet away from each other. The volume of the parent unit or app may be set too high. Decrease the volume of the parent unit or app.

NOISE/SOUND

Problem	Solution
Why don't I hear a sound? Why can't I hear my baby cry?	Perhaps the parent unit is muted. Unmute it by pressing the top part of the control button and adjust the volume. Perhaps you have muted the app. Unmute it by tapping the mute icon on the video screen.
	The sensitivity is set too low. Increase the sensitivity in the parent unit's menu or the app to a higher level.
	The baby unit may be too far away from your baby. Make sure the baby unit is not further than 1.5 meters / 5 feet away from your baby for optimal sound detection. Closer than 1 meter / 3.5 feet increases strangulation hazard.
Why does the app/parent unit react too quickly to other sounds than my baby makes?	The sensitivity level may be set too high. When your baby makes soft sounds, the sensitivity has to be higher. However, the noisier the nursery room is, the lower the sensitivity level can be set. You can change the sensitivity of your baby monitor on the parent unit's menu.

OPERATING TIME / RANGE

Problem	Solution
Why does my baby monitor manage a much smaller distance than specified in this user manual?	The specified operating range between the parent unit and baby unit is up to 400 meters / 1312 feet, and it's only valid outdoors in open air and in the line of sight. Depending on the surroundings and other disturbing factors, the operating range may be smaller (see the table in 'Operating range' chapter). Inside your house, the operating range is up to 50 meters/165 feet, which is also limited by the number and type of walls and/or ceilings between the parent unit and the baby unit.

VIDEO DISPLAY

Problem	Solution
Why do I get interference on the parent unit? Why does the video display on the parent unit flicker? Why does the parent unit make a buzzing sound?	Interference may occur when the parent unit is out of range of the baby unit. If there are too many walls or ceilings between the parent unit and the baby unit. Or when other 2.4 GHz wireless devices are switched on (e.g. microwave, Wi-Fi router). Put the parent unit in a different place, closer to the baby unit, or switch off other wireless devices.
Why isn't the image on the video display clear?	Perhaps the lens of the baby unit is dirty. Clean the lens with a dry cloth. The video resolution will automatically adjust when the parent unit is moving too far away from the baby unit. Move the parent unit closer to the baby unit.
Why do I get black and white images instead of colour ones?	The baby monitor has switched to night vision mode because the room where the baby monitor is placed is dark. If there is enough light in the room, the light sensor on the baby monitor may be covered or dirty. Make sure that this sensor is fully exposed to the light in the room.

VIDEO DISPLAY

I lose connection to the app frequently. What is the matter?

Check if the status light turns green. Check if the Wi-Fi signal in the room where the baby monitor is placed is strong enough and stable. If this is not the case, you need a Wi-Fi repeater to get a strong and stable signal. If you use a Wi-Fi repeater, make sure that your router and your Wi-Fi repeater have the same SSID and that you use the same password for the router and the repeater.

If the status light on the front of the baby monitor is solid white and you keep losing connection, there may be a problem with the Internet connection of your router, smart device or baby monitor. Check the Wi-Fi signal on your smart device or the 3G or 4G speed by trying to watch a movie, e.g. on YouTube. Or reset your Wi-Fi router.

Perhaps you have activated the privacy function, check the status light of the baby unit, if it is green, the privacy function is on. Disable it when you need to resume app reviewing.

APP /SET UP

Problem

Solution

I cannot set up the baby monitor. Each time I end up in the connection error screen. What is the matter?

Make sure your smart device uses the same Wi-Fi network you want to connect the baby monitor to.

Check the status light of the baby unit, if it is flashing red, the Wi-Fi password entered was wrong. Restart the set up process. Re-enter the Wi-Fi password and make sure that the password is correct.

Perhaps the router SSID (the network name) or the password contains special symbols. If it does, change the name of your router SSID or the password accordingly.

If the status light turns solid red while trying to connect, the baby monitor successfully connected to the router but fails to connect to the internet. Then check if you have access to 2.4GHz Wi-Fi by trying to access other apps like YouTube, Facebook etc. If other apps do not respond, please make sure you have internet access. If there is internet access, the server could be temporarily unavailable. Please try to set up again later.

Perhaps you have been trying to connect the baby monitor to a 5GHz network.

Please check that you have chosen a SSID of a network that supports 2.4 GHz.

I have problems making my baby monitor read the Wi-Fi QR code on my smart device. What can I do?

Make sure that you hold the QR code at approx. 5-15 cm / 2-6 inch distance from the baby monitor lens. Try moving the smart device slightly up, down, left or right to ensure the QR code is directly in front of the baby monitor lens. You can also try moving the smart device closer to or further away from the baby monitor lens to allow proper focussing. Make sure that there is enough light in the room, but avoid too bright light. When the baby monitor has read the QR code, you hear a confirmation sound and the status light of the baby unit turns white.

APP /SET UP

Problem	Solution
	Perhaps you did not remove the protective foil from the baby monitor lens. Remove the foil.
	Perhaps part of your hand covers the QR code. Hold your device in such a way that your hand does not cover the QR code.
I cannot see my baby. What is wrong?	Check if the Wi-Fi signal is strong enough in the room where the baby monitor is placed. The Wi-Fi status light on the front of the baby monitor must be solid white.
	Perhaps there are already three people monitoring your baby. The app only allows three people to watch simultaneously. If you have administrator rights, you can remove access for one of the guests to be able to watch yourself.
	Perhaps you have turned on the privacy function which will temporarily disconnect the connection between the baby unit and Wi-Fi router. The privacy function can be turned off in the parent unit. (see the 'Privacy function' chapter)
Why does the app not notify me that the baby is crying?	Check if the baby monitor is connected to the Wi-Fi network. The status light on the front of the baby monitor must be solid white. The sound threshold for notification may have been set too high. In that case, the app will only notify you when the baby produces a lot of sound. Open the app setting to lower the sound threshold to ensure that you are notified sooner.
	Perhaps you have muted your smart device, turn on the volume.
	Check you have activated the notification function in the app's settings.
	Check you have activated the notification function in your smart device's settings.
	Check if you have viewing rights as a guest. The notification function is disabled for guest users.
Why can't my partner and I connect to the baby monitor at the same time?	If you wish to share the same access as your partner, consider sharing the same administrator account to login to the app. Setting up the app on another device with a different login account will automatically disconnect the previously connected user. If you do not wish your partner to have full access, invite your partner to login as a guest user. Access rights of guest users have limitations. Please refer to the 'Account management' chapter for details.
Why can't I talk to the baby unit after pressing the talk back button from the app?	Perhaps your partner is talking to the baby with the parent unit. The parent unit has a higher priority in using talk back function.

APP /SET UP

Problem	Solution
How can I be a guest user?	To be a guest user, you have to register a Philips Avent Connected Baby Monitor Account before being able to view the video live streaming. Please create the account as instructed in the app, and contact the administrator that you are ready for the invitation.
I am a guest user already, why I cannot see anything when I open the app?	Perhaps the administrator has temporarily turned on the Privacy mode. You should have received a notification about this. The baby monitor may be offline. To receive a notification when the baby monitor goes offline in future, switch on app notifications from the app's settings menu.
Do I have to keep the app open to monitor my baby?	No, the app can monitor in the background while you do other things. Switch on background monitoring from the app's settings menu. You will then receive notifications on-screen when your baby makes sound.
Can I use more baby monitors in the same app?	You can connect to multiple baby monitors to the app, but you can only view the video from one baby monitor at a time. You will receive notifications from the other baby monitors connected. If you receive a notification and tap on it, the app will take you directly to that baby monitor. You can also select the baby monitor you want to view from the list.
Is the baby monitor hacker-proof?	We do everything we can to prevent hacking by issuing frequent security updates. Please make sure that you always use the latest app software and baby monitor firmware. If you lose your smart device, reset the baby monitor to remove any connections to it. You can also log in to the app from another smart device and delete your account. If you are the only administrator, all guest users will be disconnected from the baby monitor too.
I have lost my smart phone. How can I prevent strangers from viewing my baby?	Log in to the app from another smart device and deactivate your account. If you are the only administrator, this will disconnect all guest users of the app from the baby monitor. You can also reset the baby monitor to disable all connections to the device you lost. Long-press the on/off button of the baby unit for 10 seconds to reset.
Will I be notified of upgrades of the app or the baby monitor software?	Yes, you will receive a notification on your smart device to upgrade via the App Store or Google play. This will happen periodically. Upgrade notifications for the firmware of the baby monitor will appear in the app along with instructions on how to upgrade.
My phone or tablet becomes warm when I use the app. Is this normal?	Your device may get warm because it needs power to provide high-quality video. This does not harm your device. Your device does not warm up when you run the app in the background.

Wall mount

Printing instructions:

Print this page in scale 100% and use the template to accurately mark the position of the holes for the screws on the wall.

